

Primljen / Received: 18.3.2016.

Ispravljen / Corrected: 15.7.2016.

Prihvaćen / Accepted: 8.8.2016.

Dostupno online / Available online: 10.11.2016.

Behaviour of precast concrete beams prestressed with CFRP strands

Author:



Tuğçe Sevil Yaman, MCE
Mersin University, Turkey
North Carolina State University, USA
tusevil@gmail.com

Original scientific paper

[Tuğçe Sevil Yaman](#)

Behaviour of precast concrete beams prestressed with CFRP strands

Corrosion presents a serious problem in severe marine environments, especially for bridges. This paper explores the use of carbon fibre reinforced polymer (CFRP) strands for prestressing precast concrete girders. The research includes a practical prestressing process using the prestressing jacks normally applied in the precast industry. Bending tests are made on prestressed concrete T-beams (scaled models of typical T-section). The design and casting processes, and the test set-up used to load the beams up to failure, are discussed, and failure mechanisms are reviewed. Test results are compared with the ACI 318 guidelines.

Ključne riječi:

CFRP strand, concrete girder, prestressing, T-beam, bending test

Izvorni znanstveni rad

[Tuğçe Sevil Yaman](#)

Ponašanje predgotovljenih betonskih greda prednapetih pomoću CFRP užadi

Korozija predstavlja ozbiljan problem u otežanim uvjetima morskog okoliša, i to naročito kod mostova. Rad istražuje primjenu užadi izrađenih od polimera armiranog ugljičnim vlaknima (eng. *carbon fiber reinforced polymer* ili CFRP) za prednapinjanje predgotovljenih betonskih nosača. Istraživanje uključuje proces prednapinjanja pomoću uobičajenih preša koje se koriste u industriji predgotovljenih proizvoda. Provedena su ispitivanja na savijanje na prednapetim betonskim T-nosačima. Analiziran je postupak proračuna, izvedba nosača, postupak ispitivanja do sloma uz razmatranje mehanizma sloma. Rezultati ispitivanja uspoređeni su sa smjericama ACI 318.

Ključne riječi:

CFRP uže, betonski nosač, prednapinjanje, T-greda, ispitivanje na savijanje

Wissenschaftlicher Originalbeitrag

[Tuğçe Sevil Yaman](#)

Verhalten vorgefertigter mit CFRP-Seilen vorgespannter Betonträger

Korrosion stellt bei erschwerten Bedingungen durch Meerwassereinflüsse, insbesondere bei Brücken, ein ernstes Problem dar. Diese Arbeit untersucht die Anwendung von Seilen aus kohlefaserverstärktem Polymer (eng. *carbon fiber reinforced polymer* oder CFRP) zur Vorspannung vorgefertigter Betonträger. Die Untersuchungen umfassen den Vorspannvorgang mit herkömmlichen Pressen, die bei der Herstellung vorgefertigter Elemente eingesetzt werden. Es wurden Biegeversuche an vorgespannten T-Balken aus Beton durchgeführt. Das Berechnungsverfahren, die Ausführung der Träger sowie der Versuchsverlauf bis zum Versagen unter Beachtung der Versagensart wurden analysiert. Die Resultate wurden den Richtlinien gemäß ACI 318 gegenübergestellt.

Ključne riječi:

CFRP-Seil, Betonträger, Vorspannung, T-Balken, Biegeversuche

1. Introduction

Durability ranks among the most important problems of construction industry. One of the factors adversely affecting concrete durability is corrosion of steel. The fibre reinforced polymer (FRP) is a good alternative to steel usage in concrete. FRP products are starting to be used in areas such as reinforcing concrete with FRP bars instead of steel to eliminate the corrosion problem. One of the alternatives is the carbon fibre composite cable (CFCC).

The CFCC consists of PAN (polyacrylonitrile) based continuous carbon fibres, epoxy resins as adhesive material, and protective wrapping material. General properties of the CFCC are similar to those of the carbon fibre reinforced polymer (CFRP). It has configuration properties of conventional steel wire. The CFCC presents various advantages over steel strands such as the perfect corrosion resistance, light weight, high tensile strength, high tensile elastic modulus, high tensile fatigue performance, and flexibility [1].

Since the material is a relatively new technology, in-depth investigation is required. Results of the research performed by Benmokrane et al. [2] demonstrate that the strength of CFCC specimens is slightly affected by an increase in immersion time at higher temperatures. The long-term durability characterization of CFCC is needed to investigate the effect of alkaline environment at different temperatures, and under different sustained tensile load levels. Degradation of FRP composites may occur when they are exposed to environmental effects such as the moisture, alkalinity, fire and/or physical effects such as the sustained loading and fatigue. The synergistic effect of environmental conditioning and sustained loading on the long term durability of FRP has not as yet been fully examined. The aim of this large-scale research project is to determine the degradation mechanisms and estimate the service life of FRP concrete reinforcements.

This paper presents the first phase of the ongoing research project aimed at determining critical stress and safety factors for the use of the carbon fibre composite cable (CFCC) as a corrosion resistant reinforcing material for prestressed precast concrete bridge-deck and pile applications in severe marine environments. Tensile tests on CFCC samples, preparation phases of prestressed precast concrete T-beam specimens, including CFCC pre-tensioning process and design, casting of 12 CFCC reinforced beam specimens, test set-up, and instrumentation used for bending tests of 2 pre-tensioned control T-beam specimens reinforced with CFCC, are explained in the paper. Flexural responses of the beams are then discussed and test results are compared with the Code prediction.

2. State of the field

Enomoto et al. [3] described the development, usage, and application of CFCC. Moreover, case studies of the CFCC usage in bridges are presented in their paper, and the life extension

obtained in prestressed concrete bridges by using CFCC tendons and reinforcements is discussed. They mention the world's first application of CFCCs as tendons in the prestressed concrete Shinmiya Bridge in Japan in 1988. The former bridge damaged by salt corrosion was scheduled for replacement in less than twelve years after its construction. In the new bridge built at the same site, the CFCC was used to prevent salt damage. It has been in service for more than 23 years, and no changes of its properties have so far been observed.

Rizkalla and Tadros [4] described the design and construction technique used at the first highway bridge prestressed by CFRP tendons in Canada. The bridge comprised two continuous spans, each of which consisted of 13 bulb-tee section precast prestressed concrete girders. CFCCs manufactured by Tokyo Rope Manufacturing Co. Ltd., Japan, were utilized to pretension four girders, and leadline rod tendons produced by Mitsubishi Kasei, Japan, were used to pretension the other two girders. Post-tensioned steel tendons along the entire length of the bridge were used to ensure continuity of the two spans. An experimental program was conducted by Abdelrahman et al. [5] to study the behaviour of four prestressed concrete T-beams having the same span-depth ratio as the bridge girders. The beams were tested under static and cyclic loads to investigate various limit state behaviours, ultimate capacities, and failure modes.

The design and construction procedures for the Bridge Street Bridge, the first CFRP prestressed concrete bridge in the United States, were explained by Grace et al. [6]. The project consisted of two parallel bridges, A and B. Both structures consisted of three spans. Structure A comprised a new substructure and a new superstructure. It contained five equally spaced precast concrete I-girders in each of its three spans. Its continuous concrete deck slab was placed across the spans. Structure B had four prestressed double-tee (DT) girders in each of its spans and a non-continuous deck slab. Grace et al. [7] carried out an experimental study on a full scale CFRP/CFCC DT girder to guarantee successful performance of the bridge. The girder had the same design as the girders of the bridge. It was designed to simulate performance of bridge girders, and was tested under four-point bending. Theoretical calculations were also made. The girder tested in this way was found to have major reserve strength beyond service load. Analytical and experimental results were similar to each other, particularly with regard to service load.

The issue of bond properties of CFCC prestressing strands in pretensioned concrete beams was investigated through an experimental program conducted by Domenico [8]. Bond properties were studied by transfer and development length measurements and by determination of the corresponding bond stresses. Ten CFCC pretensioned concrete beams were tested using various shear span values. Equations were developed to predict transfer and flexural bond lengths for CFCC. It was observed that the equations were in perfect correlation with measured values.

Fam et al. [9] tested I-girders to examine the behaviour of CFRP as prestressing and shear reinforcement for concrete bridges. The effect of CFRP stirrup configuration and size on shear behaviour, and performance in supplying dowel action between girder and top slab were studied. The draping effect of CFRP prestressing tendons was also presented. CFRP prestressed beams demonstrated similar stiffness to the beam prestressed by steel strands. It was concluded that the draping of CFRP tendons did not affect flexural capacity. Yet, flexural failure could be expected at bent point locations. No slip of prestressing reinforcement was observed.

An experimental research on flexural behaviour of two identical box-beam bridge models reinforced and prestressed with different types of CFRP tendons/strands was performed by Grace et al. [10]. The first model was reinforced and prestressed with CFRP-DCI tendons, and the second one with CFCC strands. According to test results, it was concluded that both bridge models showed identical flexural behaviour, particularly as to the cracking load, mode of failure, and variation in post-tensioning forces.

Flexural performance of three concrete box-beam bridge models prestressed and reinforced with CFCCs was studied by Grace et al. [11]. The research primarily focused on the effects of the unbonded longitudinal post-tensioning usage. Test results showed that a greater total prestressing force prolonged crack development and reduced crack number and size. It also reduced the amount of residual deflection. It was observed that members having greater total prestressing force could fail suddenly. Moreover, more inelastic energy was dissipated during progressive failures compared to sudden failures. The prestressing strand was not utilized to full potential when a compression failure occurred. It was also concluded that the effect of prestress at transfer and concrete strength should be considered while estimating transfer length.

Grace et al. [12] conducted an experimental and analytical research to study flexural behaviour of decked bulb T-beams reinforced and prestressed with different kinds of FRP materials. Test results showed that the performance of CFRP tendons or CFCC strands reinforced beams was comparable to that of the control beam, prestressed and reinforced with conventional steel strands and bars, at both service and ultimate limit states. Beams tested demonstrated a high load carrying capacity with large deflection and reasonable amount of absorbed energy prior to failure. It was concluded that FRP reinforced decked bulb T-beams could be safely applied to improve the performance and prolong the life span of bridges.

Shear behaviour of prestressed decked bulb T-beams having CFCC stirrups was investigated by Grace et al. [13]. The effect of shear span-to-depth ratio and transverse reinforcement type on the shear carrying capacity was studied in this research. Four beams reinforced and prestressed with CFCC were tested under shear loading. A half span of each beam had CFCC stirrups and the other half was reinforced with steel stirrups. Beam ends having CFCC stirrups failed due to either concrete web crushing or top concrete compression failure, whereas the beam ends

with steel stirrups failed in shear tension mode. It was concluded that CFCC stirrups could be used as a non-corrosive option to steel stirrups in bridge girders.

Roddenberry et al. [14] conducted an experimental study to examine the convenience of using CFCCs instead of standard steel strands. Five square prestressed concrete piles having CFCC strands were tested to identify the performance of CFCC. The transfer length was observed on each pile end and compared to prediction equations to interpret bond behaviour of CFCC. Moreover, development length tests and flexural tests were performed to further investigate the performance of CFCC. Finally, two piles were driven at a site adjacent to steel prestressed concrete piles, and their behaviour was monitored. Test results indicated that the behaviour of CFCC prestressed piles was comparable to that of steel prestressed ones. It was concluded that the usage of CFCC strands as prestressing could result in bridges characterized by lower maintenance requirements and longer service life.

Shapack [15] performed a research to analyse and design cored slabs prestressed with CFRP strands and reinforced with GFRP stirrups. Direct tension tests were conducted to confirm material properties given by FRP manufacturers. Beam-end samples were tested to compare bond properties of CFRP and steel strands. Flexural and shear specimens were tested to evaluate the performance of FRP reinforced cored slabs in bending and shear relative to steel reinforced ones. Test results showed that FRP reinforced cored slabs demonstrated equivalent or better performance in monotonic flexure and shear compared to steel reinforced cored slabs. It was concluded that according to the performance exhibited by FRP reinforced sections and also perfect durability of FRP reinforcement, the proposed cored slab design should be an efficient and sustainable solution.

3. Material background

The CFCC strand was selected for the experimental program due to its corrosion resistance. In this first step of the project, CFCCs measuring 15.20 mm in diameter, manufactured by Tokyo Rope Manufacturing Co. Ltd., Japan, were utilized as prestressing reinforcement for precast concrete T-beams. A CFCC strand is presented in Figure 1.



Figure 1. View of CFCC prestressing strand

Table 1. Standard specifications for CFCC [16]

Cross section	Designation	Diameter [mm]	Effective cross-sectional area [mm ²]	Guaranteed breaking load [kN]	Unit weight per meter [g/m]	Elastic modulus [kN/mm ²]	Ultimate tensile strain [%]
7 wires	1x7	15.20	115.60	270.0	221.0	155.0	1.51

It is actually a stranded cable consisting of twisted carbon wires. Individual wires are composed of carbon fibres and epoxy resin. Moreover, each wire is covered with polyester resin for protection purposes. The twisted 7-wire geometry of CFCC improves its adhesion to concrete. The standard specifications for the 15.20 mm diameter CFCC supplied by the manufacturer is presented in Table 1.

4. Tensile testing of CFCC strands

Six CFCC prestressing strand specimens 15.20 mm in diameter were tested by Shapack [15] under tension according to ASTM D7205 in the Constructed Facilities Laboratory at North Carolina State University, NC. The specimens measured 1.22 m in length. Since CFCC is weak in transverse compression, holding the specimens directly could cause damage to the ends. For this reason, steel sleeves 0.31 m in length were attached to the ends of the specimens. In this way, the tensile testing machine could hold the specimens tightly in transverse direction. Two methods were utilized for measuring strain in the strands. The first one involved the use of an uniaxial strain gauge. A small strain gauge was selected to fit an individual CFCC strand. It was a general purpose gauge having a gauge length of 1.52 mm, overall length of 4.45 mm, grid width of 1.27 mm, overall width of 2.03 mm, matrix length of 6.40 mm, and matrix width of 4.32 mm. A CFCC specimen with strain gauge is shown in Figure 2.



Figure 2. CFCC specimen with strain gauge [15]



Figure 3. Tensile testing of CFCC sample with extensometer [15]

Strain gauges were used for the first two CFCC sample tests only. Since strain gauges debonded during the tests, an extensometer was used in the remaining tests. However, the extensometer was removed at a load level of 70 % of the ultimate load to prevent damage, and the specimens were put inside a tube to take into account possible explosion of the material. Strain data were only taken for the first 40 % - 70 % of the loading curve. CFRP specimens were loaded monotonically at the rate of 1.27 mm/min. The tensile testing of a CFCC sample with extensometer is shown in Figure 3. Failure was observed as rupture for each specimen. Since CFCC is brittle, no yielding was observed and the stress-strain behaviour was linear. The appearance of a specimen after testing is shown in Figure 4.



Figure 4. CFCC specimen after testing [15]

The stress vs. strain graph resulting from tensile testing of CFCC strands is given in Figure 5. The solid lines represent the part of the test in which strain data were collected. The dashed line represents the perfectly linear behaviour with an average modulus of elasticity and rupture stress from all tests. Results obtained from the tensile tests, and the corresponding values given by the manufacturer Tokyo Rope Manufacturing Co. Ltd., are summarised in Table 2. The mechanical property values obtained from the tests and the manufacturer's values were very close to each other, and it can therefore be stated that the manufacturer's values were confirmed by the tests [15].

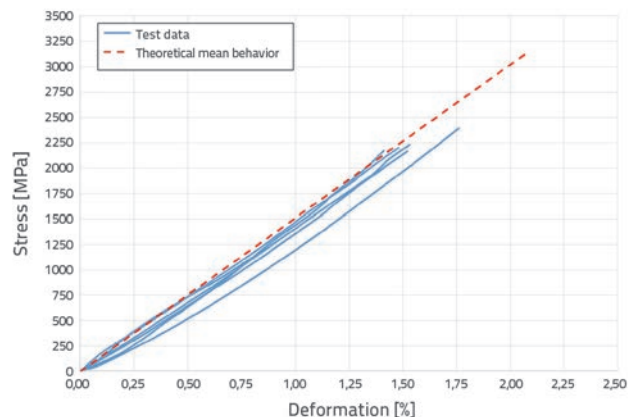

Figure 5. Stress vs. strain graph for CFCC tension tests [15]

Table 2. Summary of tensile test results [15]

Sample number	Ultimate capacity [kN]	Ultimate strain [%]	Ultimate stress [MPa]	Elastic modulus [GPa]
#1	374.10	2.13	3238.47	151.75
#2	343.85	2.06	2977.16	144.38
#3	369.65	2.14	3201.24	149.90
#4	375.88	2.21	3254.33	147.01
#5	377.65	1.97	3256.39	165.05
#6	360.75	2.07	3124.02	151.18
Average	366.98	2.10	3175.04	151.55
Manufacturer's data	369.20	2.11	3190.20	151.00

5. Preparation of prestressed precast concrete T-beam specimens

5.1. Details on test specimens

T-beam specimens are 3.35 m in length, 304.80 mm in total height, 304.80 mm in web width, 914.40 mm in flange width, and 76.20 mm in flange thickness. All beam samples have the same geometrical configuration. Specimen dimensions are given in Figure 6.

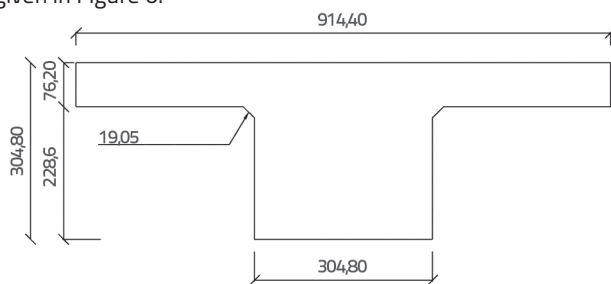

Figure 6. Dimensions (in mm) of test specimens

The objectives of this study, which is the first phase of an ongoing research project, are to determine behaviour of precast concrete beams prestressed by CFCC strands, and to compare the test results with the ACI Code prediction. After this first phase, the beams will be subjected to severe environmental conditions to study their long term behaviour. The objectives of the entire research project are to investigate degradation of CFCC under sustained tensile loading in a highly alkaline environment, to quantify structural performance of CFCC under accelerated ageing, and to evaluate service life of FRP reinforcements in concrete based on degradation mechanisms. For that reason, the beams were designed according to ACI 318 [17] to achieve rupture in CFCC, in order to observe the effects of sustained loading and/or ageing, before crushing of concrete. The design was performed according to actual test results given by the manufacturer and the test results obtained by Shapack [15]. In other words, the design was not based on the guaranteed values. The reinforcement pattern of the test specimens is shown in Figure 7. The same reinforcement detail was utilized for all test specimens.

The T-beam specimen casting form was constructed and reinforcement was inserted. A picture of the form after insertion of reinforcement is presented in Figure 8.

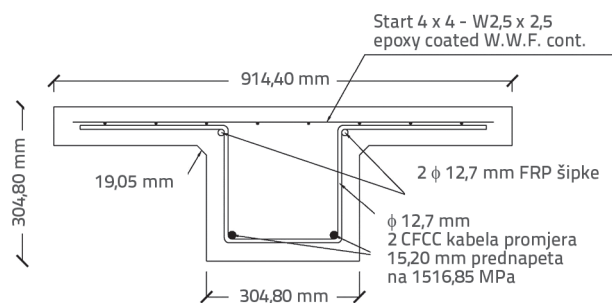

Figure 7. Reinforcement pattern of test specimens



Figure 8. Form after placing reinforcement

5.2. CFCC pre-tensioning process

Special preparations were made before passing on to the pre-tensioning step. Both ends of the strands were coupled to prestressing steel strands. CFCC strands were cut to required lengths and inserted into the form. Both ends of the strands were prepared for the pre-tensioning operation. The inside of

the CFCC sleeve was sprayed by a dry moly spray. Afterwards, the sleeve was inserted in the CFCC strand. A helical buffer material was wrapped around the ends of the strand and it was fixed with an electrical tape. A layer of braid grip was placed over the buffer mesh. Then, it was tightly squeezed to clear wrinkles and taped to the strand. The buffer material and the braid grip were used to prevent direct contact of the wedges and the strand, which could cause damage to the strand. Later, the wedges were inserted into a wedge guide placed onto the strand. The wedges were pushed into the sleeve manually by a hand pump. Then, the sleeve and the wedges were placed into the seating ram assembly. The steel side of the coupler was slid into the steel strand and a standard chuck was placed onto the steel strand. Thereafter, the coupler was pulled up to the steel strand chuck. Then, the coupler was screwed onto the sleeve. The couplers were positioned in a staggered alignment so as not to touch each other during tensioning. A view of CFCC strands before tensioning is given in Figure 9.



Figure 9. CFCC strands before tensioning

After the end of the preparation phase, the tensioning was applied in two steps. In the first step, each strand was tensioned to 22.24 kN to make sure that the CFCC strands do not wrap around each other. In the second step, the tensioning continued to the required load of 175.71 kN. Each precast concrete T-beam was pre-tensioned by two CFCC strands. The stress in the strands at the time of initial prestressing was 65 % of the ultimate strength, which is less than the Code recommended value of 80 % for steel tendons, and is due to the lack of ductility of these type of CFCC strands. CFCC strands after tensioning are shown in Figure 10.



Figure 10. CFCC strands after tensioning

5.3. Casting of concrete

After prestressing of CFCC strands, the concrete mix was poured into the formwork. All 12 T-beam specimens were cast on the same bed. A picture of the specimens after concrete casting is given in Figure 11. To determine the compressive strength of concrete, a total of 24 cylindrical specimens measuring 10.16 x 20.32 cm were taken for 12 beam samples to be tested according to ASTM C39 [18]. For two control beam specimens, three concrete cylinder samples were tested at the test day. Compressive strength results for concrete are given in Table 3.



Figure 11. Beam specimens after casting of concrete

Table 3. Compressive strength of concrete at test day

Cylinder specimen	Compressive strength of concret [MPa]
1	74.13
2	75.55
3	77.03
Average	75.57

6. Test set-up and instrumentation

Two prestressed precast concrete control T-beam specimens were tested in the Constructed Facilities Laboratory at North Carolina State University, NC. The specimens were tested under 3-point bending. The test set-up consisted of a strong floor, 2 concrete blocks, a hinge and a roller support, loading equipment, instrumentation, and a data acquisition system.

First, the concrete blocks were placed at the sides. The hinge support was then put on the left block and, similarly, the roller

support was put on the right block. The left and right directions were determined from the front of the beam model. Afterwards, the specimen was placed on the supports. A 45.72 cm long steel HSS measuring 10.16 x 10.16 cm in cross-section was placed in the middle of the specimen. Two steel bars were passed through two holes on the floor, spaced 0.91 m from one another, and fixed to the strong floor from the basement. A spreader beam 1.22 m in length was laid on the HSS. The two steel bars were passed through two holes at the sides of the spreader beam. Two cylindrical plates were then placed on the sides of the spreader beam and two load cells 222.41 kN in capacity were positioned on the plates to measure the load. Two washers and two square plates were placed on the load cells and two hydraulic jacks 533.79 kN in capacity were set on these plates. Then, two square plates were put on the hydraulic jacks. Finally, two bolts were put on the plates for fixing. This completed the loading equipment placement part. This placement type provided transfer of load from the spreader beam to the HSS and then to the beam specimen accordingly.

The instrumentation was then placed. It consisted of two load cells, a string potentiometer, three pi gauges, and four linear potentiometers. As previously mentioned, the load cells were positioned during the loading equipment placement phase. So, the remaining instrumentation was placed in this step. A string potentiometer of 10.16 cm stroke was placed at the bottom part of the specimen mid-span to measure deflections. A pi gauge was positioned at the bottom surface and two pi gauges were placed at the top surface of the beam at mid-span to measure compressive strain at the top surface and tensile strain at the bottom surface, which includes the cracks. Also, two linear potentiometers, each 3.81 cm in stroke, were placed to the left end of the specimen, one on the strand end at the bottom left of the web and one on the strand end at the bottom right of the web, to measure any strand slip at the left end of the model. Similarly, two linear potentiometers each 3.81 cm in stroke were placed to the right end of the specimen at the ends of the strands. General views of the test set-up with instrumentation are given in Figures 12 and 13.



Figure 12. Front view of test set-up



Figure 13. Perspective view of test set-up

7. Test results and observed behaviour

7.1. Beam specimen ST-CONTROL 1

The first 3-point bending test was conducted on the control beam specimen ST-CONTROL 1. Test results concerning this specimen will be used as a reference for behaviour of the remaining ten beam specimens which are going to be subjected to sustained tensile loading and/or ageing. The test specimen was initially loaded up to 223.70 kN. First crack occurred at the load of 126.24 kN and the mid-span deflection amounted to 2.21 mm. The mid-span deflection corresponding to 223.70 kN load was 34.23 mm. The mid-span bottom and top strains at that load level were 0.012 tensile and 0.002 compressive, respectively. This was followed by unloading. There was a punching problem because of the washer situated on top of the front load cell. Two square plates were also placed at the front and back load cells to solve this problem. The appearance of the test specimen after initial loading and unloading is shown in Figure 14.



Figure 14. Test specimen after initial loading and unloading

The specimen was then loaded up to the failure load of 260.22 kN. The corresponding mid-span deflection at this failure load was

44.70 mm. The mid-span bottom and top strains at the failure load were 0.011 tensile and 0.002 compressive, respectively. The first partial rupture of the CFCC strand occurred at the mid-span. Then a 3.25 cm slippage was observed at the right end of the front strand. The appearance of beam sample at failure is given in Figure 15. The strand slippage is shown in Figure 16. The existence of rupture was proven by the chipping operation performed on the specimen after the test. The rupture of the strand after chipping is shown in Figure 17. Load vs. mid-span deflection graph is presented in Figure 18. It should be noted that the initial upward deflection, i.e. camber, due to prestressing of strands, is taken to be zero at all load vs. mid-span deflection graphs. Thus, graphs start from zero, rather than from a negative camber deflection value. Also, the load vs. mid-span strain graph is shown in Figure 19.



Figure 15. Beam specimen at failure



Figure 16. Slippage at right end of front CFCC strand



Figure 17. Rupture of the strand after chipping

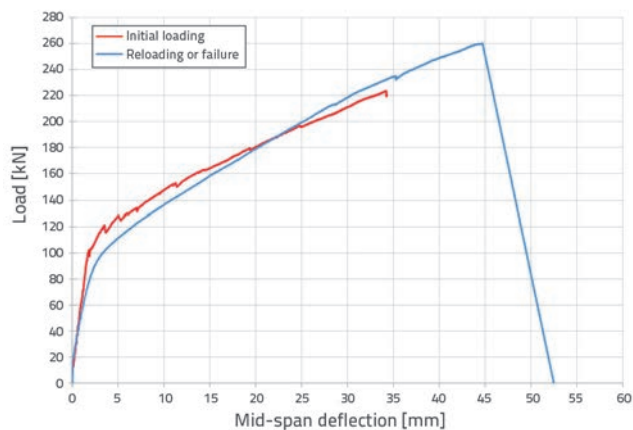

Figure 18. Load vs. mid-span deflection graph of ST-CONTROL 1 specimen

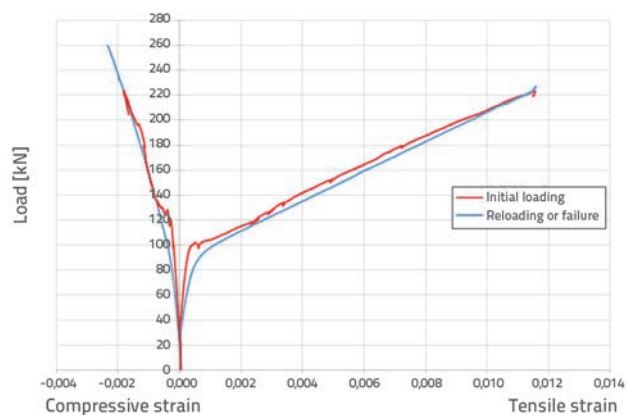

Figure 19. Load vs. mid-span strain graph of ST-CONTROL 1 specimen

7.2. Beam specimen ST-CONTROL 2

The second 3-point bending test was conducted on the control beam specimen ST-CONTROL 2. Test results for this specimen will also be utilized as a reference for the behaviour of the remaining ten beam models. The test sample was loaded up to the failure load of 262.98 kN. The first crack occurred at 121.54 kN and the mid-span deflection amounted to 2.19 mm. The mid-span deflection corresponding to 262.98 kN load was 53.58 mm. The mid-span bottom and top strains at the failure load were 0.035 tensile and 0.003 compressive, respectively. The specimen during the test, just prior to the failure, is shown in Figure 20. First, a partial rupture of a strand occurred at the mid-span. Then, crushing of concrete at the mid-span top region of the beam specimen, accompanied by flexure failure, was observed. No strand slippage was registered. The beam model after the test is shown in Figure 21. The specimen appearance after chipping is presented in Figure 22. The load vs. mid-span deflection graph is shown in Figure 23. The load vs. mid-span strain graph is given in Figure 24.



Figure 20. Test specimen just before failure



Figure 21. Beam model after test



Figure 22. Specimen after chipping

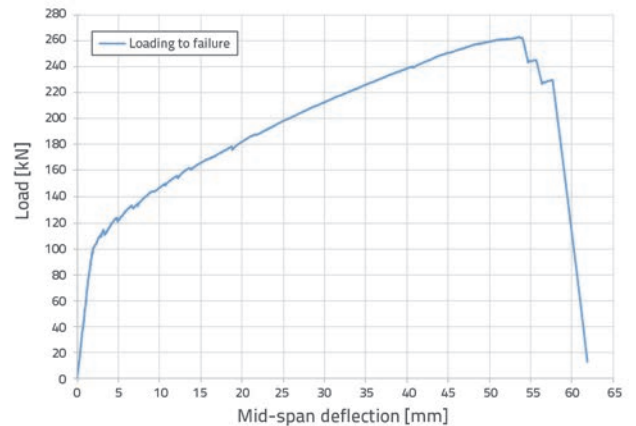

Figure 23. Load vs. mid-span deflection graph of ST-CONTROL 2 specimen

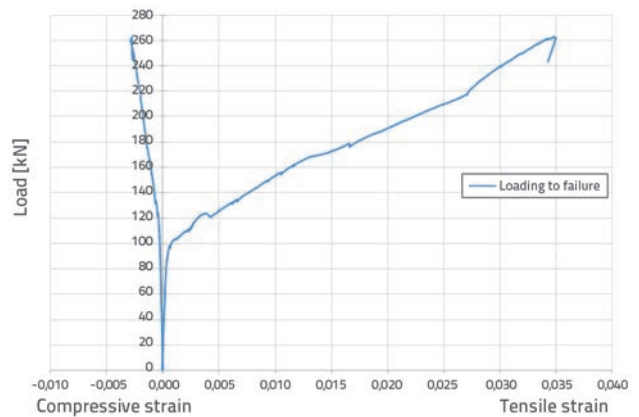

Figure 24. Load vs. mid-span strain graph of ST-CONTROL 2 specimen

8. Discussion of test results

The failure of any prestressed concrete beam typically occurs by the crushing of concrete in the compression zone. However, due to the overall objective of the study these beams were designed to fail by rupture of CFCC strands before the strain in the compression zone reached its ultimate value in order to investigate the effects of sustained loading and/or ageing. The design was made according to ACI 318 [17] considering actual test results supplied by the manufacturer and the test results obtained by Shapack [15], i.e. it is not based on the guaranteed values. In the design of the beams, first the top and bottom stresses were checked in the transfer stage and service stage. Thereafter, the flexural design was performed. During the flexural design, the neutral axis location was first determined. Then, the strain compatibility calculations were conducted. After the flexural design, the nominal flexural capacity was calculated. Later on, the shear design was performed. The short and long term deflections were calculated in the last step. In the design, the compressive strength of concrete was first assumed

to be 55.15 MPa. Afterwards, the compressive strength value of concrete was updated to 75.57 MPa in the design using the actual results from the concrete cylinder tests, and the calculations were performed accordingly. For CFCC strands, the modulus of elasticity, ultimate tensile strain, and stress, amounting to 155 GPa, 0.021, and 3.24 GPa, respectively, were used in the design.

Partial rupture of a CFCC strand was observed at the end of the test of the first control beam sample ST-CONTROL 1. Then a slippage occurred at the right end of the front strand. Partial rupture of a strand occurred during the test of the second control beam specimen ST-CONTROL 2. Concrete crushing was then observed at the mid-span top of the model, causing flexural failure. The strand slippage did not occur. The behaviour of two control test beam specimens at failure demonstrated validity of the design, which was aimed at obtaining rupture of the CFCC strands before concrete crushing.

After comparison of the load vs. mid-span deflection graphs of both beam specimens, it was established that the graph of the initial loading of the first test coincides with the graph of the second test. This is a good indication. If no problem was caused by the washer during the first test and if the load was continued to failure, the graphs would most probably match each other from the beginning to the end. The combined load vs. mid-span deflection graphs of the first and the second tests are presented in Figure 25.

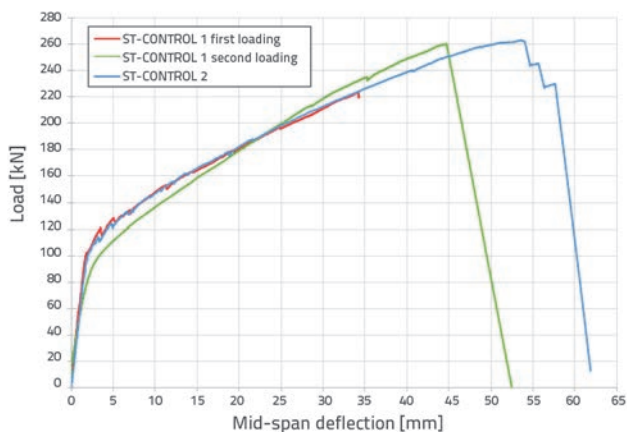

Figure 25. Combined load vs. mid-span deflection graphs of ST-CONTROL 1 and ST-CONTROL 2 specimens

When actual concrete compressive strength of 75.57 MPa was taken in the design, the prestressing reinforcement strain at the bottom amounted to 0.038 at failure, and strain at the top reached the ultimate concrete strain value of 0.003. The strain value of 0.038 in CFCC strands is higher than the ultimate strain of strands, i.e. 0.021. This guaranteed that the failure would result from rupture of the strands. In order to check the strain value in concrete at the top, if the prestressing reinforcement strain is taken as the ultimate strain in CFCC, 0.021, which

means that the failure of the strands would occur, the concrete strain at the top is 0.001, which is less than the ultimate concrete strain value of 0.003. It was seen from the results that concrete would not crush at the time when failure of the strands would occur.

In the first test ST-CONTROL 1, if the test results are evaluated in terms of strain, the mid-span bottom and top strains at failure load were 0.011 tensile and 0.002 compressive, respectively. In the second test ST-CONTROL 2, the mid-span bottom and top strains at failure load were 0.035 tensile and 0.003 compressive, respectively. The design and first test strain values do not match well. This is perhaps due to the fact that the specimen was subjected two times to the loading. On the other hand, the design values are in good accordance with the second test strain results, where the specimen was loaded once to failure. It should also be noted that the mid-span bottom strain test values at failure were obtained from the pi gauge at the mid-span bottom part of the specimen, rather than the strain values of the CFCC strands. However, the bottom strain at failure calculated in the design is the strain value of the CFCC strands. Thus, it is normal to obtain a difference between the design and test strain values.

The nominal moment capacity was calculated based on the ultimate strength of the CFCC. Predicted values based on the actual compressive strength of concrete were calculated in the design using the compressive strength value of 75.57 MPa as obtained from the concrete cylinder tests. The nominal moment capacity and failure load were obtained as 184.24 kNm and 241.98 kN, respectively. The cracking moment value was determined as 90.33 kNm, and the calculated cracking load amounted to 118.50 kN.

The cracking load and failure load values obtained during the first test amounted to 126.24 kN and 260.22 kN, respectively. The cracking and failure loads obtained during the second test amounted to 121.54 kN and 262.98 kN, respectively. The design and test values of the cracking and failure load are close to each other. The test results confirmed the accuracy of the design values. In prestressed concrete beams, deflection depends on the prestressing force and dead and live loads. Deflections due to flexural deformations were taken into account while shear deformations were neglected in the calculations. The short-term deflection of the beam at mid-span was calculated using the bilinear computation method described in Nawy's book [19]. When the actual compressive strength of concrete was taken, and the predicted design cracking load and failure load values of 118.50 kN and 241.98 kN, respectively, were used, the short-term deflection at mid-span amounted to 41.58 mm.

At the first test of the control beam specimen ST-CONTROL 1, the mid-span deflection amounted to 45.21 mm when using the actual concrete compressive strength value and the cracking load and the failure load values of 126.24 kN and 260.22 kN, respectively. The mid-span deflection at failure was 44.70 mm in the first test. There is a difference of 0.51 mm between the values, which is a good indication that the calculated and tested

Table 4. Comparison of predicted design values and test results

	Tensile strain at failure	Cracking load P_{cr} [kN]	Failure load P_f [kN]	Mid-span deflection [mm]
Predicted design values ($f_c' = 55.15$ MPa)	0.030	112.10	240.20	44.58
Predicted design values for ($f_c' = 75.57$ MPa)	0.038	118.50	241.98	41.58
				45.21 (Using ST-CONTROL 1 actual P_f value)
ST-CONTROL 1 actual values	0.011	126.24	260.22	44.70
ST-CONTROL 2 actual values	0.035	121.54	262.98	53.59

mid-span deflection values match each other well. Afterwards, the use was made of the actual concrete compressive strength value and the cracking load and the failure load of 121.54 kN and 262.98 kN, respectively, of the test ST-CONTROL 2, so as to check the mid-span deflection value obtained in the second control beam sample test. The mid-span deflection of 47.75 mm was calculated using these values, and the mid-span deflection value of the second test amounted to 53.59 mm. There is a difference of 5.84 mm between the values.

A summary containing comparison of the design and test results for cracking load, failure load, tensile strain at failure, and deflection at mid-span, is presented in Table 4. The difference between numerical and test results may be attributed to the model used, different material properties, and effect of shear. Figure 26 shows the predicted load vs. mid-span deflection graph obtained by calculating predicted short-term mid-span deflection values, by taking load increments of 20.0 kN up to the failure load of 241.98 kN, as obtained in the design using actual concrete compressive strength values. The load vs. mid-span deflection graphs of ST-CONTROL 1 and ST-CONTROL 2 tests are also presented in this figure. Moreover, the guaranteed failure load of the beam is calculated as 171.75 kN by taking actual concrete compressive strength of concrete as 75.57 MPa and the ultimate tensile strain and stress values as 0.015 and 2.34 GPa, respectively, for CFCC, and by performing the design again. The guaranteed value is also presented in the graph. The guaranteed breaking load of 270.0 kN and effective cross sectional area of 115.60 mm² given by the manufacturer were used when calculating the stress value of 2.34 GPa for CFCC. In addition, the ultimate tensile strain value of 0.015 is the value given by the manufacturer. When the combined graph is evaluated, it can be observed that the predicted and test load vs. mid-span deflection graphs fit each other well. It can also be seen that the calculated guaranteed failure load of the beam remains below the predicted and test values.

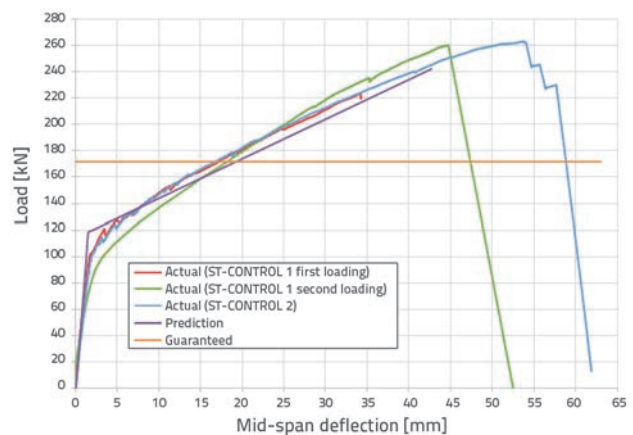
**Figure 26. Comparison of calculated and test load vs. mid-span deflection graphs**

9. Conclusion

The usage of CFRP strands for prestressing precast concrete beams was investigated in this study. The study constituted the first step of an ongoing research project aimed at determining the degradation mechanisms and estimating the service life of the FRP concrete reinforcement. The paper reviews tensile tests of CFCC specimens, the design, prestressing, and casting processes, test set-up, and instrumentation used for the bending tests. It discusses flexural response of beam models and compares the results with the ACI 318 Code prediction. The bending test specimens were designed to obtain rupture in the strands so as to observe the effects of sustained loading and/or ageing, before concrete crushing. The behaviour of the beam specimens is compliant with design expectations. Also, the load vs. mid-span deflection graphs of the initial loading in the first test and the second test coincided, which was a good indication. The design findings and test results were in good compliance in terms of tensile

strain at failure, cracking and failure loads, and mid-span deflection. The test results confirmed correctness of the design values.

Since the first phase of the research project was completed with good bending test results for 2 pre-tensioned control T-beam specimens, the next step can be initiated, and the test results can be safely used as reference for the behaviour of the remaining ten beam models.

REFERENCES

- [1] Enomoto, T., Ushijima, K.: Use of CFCC Tendons and Reinforcements in Concrete Structures for Durability, The Third Asia-Pacific Conference on FRP in Structures (APFIS 2012), Sapporo, Hokkaido, Japan, pp. 1-8, 2012.
- [2] Benmokrane, B., Ali, A.H., Mohamed, H.M., Robert, M., ElSafty, A.: Durability Performance and Service Life of CFCC Tendons Exposed to Elevated Temperature and Alkaline Environment, *Journal of Composites for Construction*, 20 (2016) 1, pp. 1-13.
- [3] Enomoto, T., Grace, N.F., Harada, T.: Life Extension of Prestressed Concrete Bridges Using CFCC Tendons and Reinforcements, 6th International Conference on FRP Composites in Civil Engineering (CICE 2012), Rome, Italy, pp. 1-10, 2012.
- [4] Rizkalla, S., Tadros, G.: A Smart Highway Bridge in Canada, *Concrete International*, 16 (1994) 6, pp. 42-44.
- [5] Abdelrahman, A., Tadros, G., Rizkalla, S.: Test Model for the First Canadian Smart Highway Bridge, *ACI Structural Journal*, 92 (1995) 4, pp. 451-458.
- [6] Grace, N.F., Navarre, F.C., Nacey, R.B., Bonus, W., Collavino, L.: Design - Construction of Bridge Street Bridge - First CFRP Bridge in the United States, *PCI Journal*, 47 (2002) 5, pp. 20-35.
- [7] Grace, N.F., Enomoto, T., Abdel-Sayed, G., Yagi, K., Collavino, L.: Experimental Study and Analysis of a Full-Scale CFRP/CFCC Double-Tee Bridge Beam, *PCI Journal*, 48 (2003) 4, pp. 120-139.
- [8] Domenico, N.G.: Bond Properties of CFCC Prestressing Strands in Pretensioned Concrete Beams, M,Sc, Thesis, Department of Civil and Geological Engineering, University of Manitoba, Winnipeg, Manitoba, 1995, pp. 118.
- [9] Fam, A., Rizkalla, S., Tadros, G.: Behavior of CFRP for Prestressing and Shear Reinforcements of Concrete Highway Bridges, *ACI Structural Journal*, 94 (1997) 1, pp. 77-86.
- [10] Grace, N.F., Enomoto, T., Sachidanandan, S., Puravankara, S.: Use of CFRP/CFCC Reinforcement in Prestressed Concrete Box-Beam Bridges, *ACI Structural Journal*, 103 (2006) 1, pp. 123-132.
- [11] Grace, N., Enomoto, T., Abdel-Mohti, A., Tokal, Y., Puravankara, S.: Flexural Behavior of Precast Concrete Box Beams Posttensioned with Unbonded, Carbon-Fiber-Composite Cables, *PCI Journal*, 53 (2008) 4, pp. 62-82.
- [12] Grace, N., Enomoto, T., Baah, P., Bebawy, M.: Flexural Behavior of CFRP Precast Prestressed Decked Bulb T-Beams, *Journal of Composites for Construction*, 16 (2012) 3, pp. 225-234.
- [13] Grace, N.F., Ushijima, K., Rout, S.K., Bebawy, M.: Shear Behavior of Prestressed Decked Bulb T-Beams Reinforced with CFCC Stirrups, The Fourth Asia-Pacific Conference on FRP in Structures (APFIS 2013), Melbourne, Australia, pp. 1-6, 2013.
- [14] Roddenberry, M., Mtenga, P., Joshi, K.: Investigation of Carbon Fiber Composite Cables (CFCC) in Prestressed Concrete Piles, Florida Department of Transportation, Tallahassee, Florida and Florida State University, Tallahassee, Florida, 2014.
- [15] Shapack, G.L.: Analysis and Design of Cored Slabs Prestressed with Carbon Fiber Strands, M,Sc, Thesis, Graduate Faculty, North Carolina State University, Raleigh, NC, 2015, pp. 129.
- [16] Tokyo Rope Manufacturing Co, Ltd., General information of CFCC: carbon fiber composite cable, standard specifications, <http://www.tokyorope.co.jp/english/products/cfcc/material/index.html>, 15.1.2016.
- [17] ACI 318: Building Code Requirements for Structural Concrete and Commentary, American Concrete Institute (ACI), Farmington Hills, MI, 2011.
- [18] ASTM C39: Standard Test Method for Compressive Strength of Cylindrical Concrete Specimens, ASTM International, West Conshohocken, PA, 2015.
- [19] Nawy, E.G.: Prestressed Concrete- A Fundamental Approach, Fifth Edition Update ACI, AASHTO, IBC 2009 Codes Version, Prentice Hall, Upper Saddle River, NJ, 2009.

Acknowledgements

The author sincerely expresses her gratitude to Distinguished Professor Sami H. Rizkalla for his guidance and support. Also, the author presents her thanks to Ph.D. student Omar Khalaf Alla for his effort and assistance.